

# PRODUCT DATA

## H60-AC

Premium Efficiency  
For Open Ceilings Up To 60ft

REDUCED CARBON FOOTPRINT

LOWER OPERATING COSTS

INCREASED COMFORT

LESS RUN TIME

FAST PAYBACK



ZOO Fans' proprietary stator ring reduces centrifugal and angular flow, straightens the air column, boost air speed, and significantly increases throw.



**ZOO Fans®** energy-efficient fans create a concise column of air that gently mixes the air from ceiling-to-floor and wall-to-wall. ZOO fans destratify the air, eliminate hot and cold spots, and increase overall air circulation. **Noticeably improve comfort, and save energy!**

### H-Series Fans deliver proven efficiency and performance that is unmatched by other fans

- ZOO fans are the only destratification fans that are independently tested in an industry-certified laboratory for guaranteed performance
- Variable speed controllable to dial-in comfort, individually, or in zones
- Easy to control—manually, automatically, or by a building automation system (BAS)
- Contributes to LEED

## Motor

- Composite fan blades deliver even greater efficiency
- Thermal overload protection
- Sealed, lifetime lubricated bearings

## Installation Hardware Included

- 8 ft Cable with fast-locking Gripple® and attachment hardware
- 12 ft Stabilization Tether with fast-locking Gripple and attachment hardware

## Options

- 6 ft Cord, 3-Prong Plug, 115V only
- Colors: Off-White or Black
- Exhaust Safety Grill (additional charge)
- Controllers (additional charge)

## Housing

- Durable double-wall construction with UV treated, flame resistant plastic
- Patented design significantly outperforms the competition
- Intake Safety Grill is standard

## Coverage

Each fan covers from 1200-2500 sq. ft., depending on the following variables:

- Ceiling height and square footage
- Targeted number of air-turns per hour

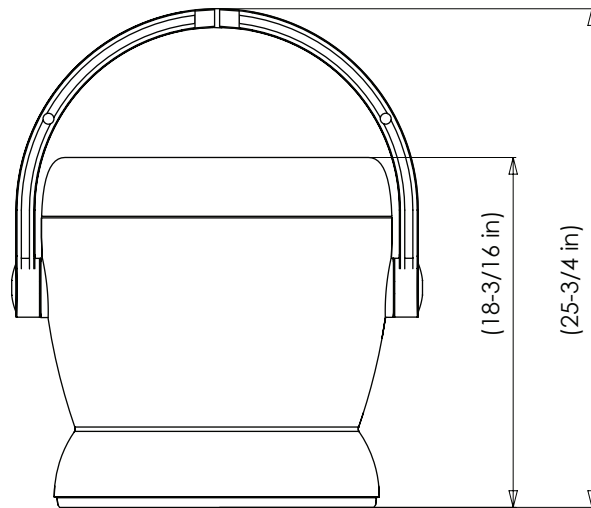

Side View

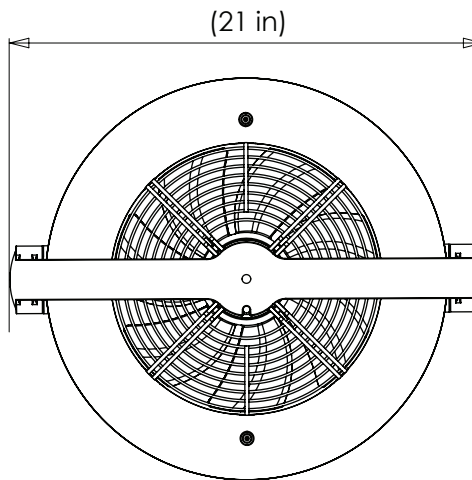

Top View

## Specifications

Model	H60 Premium Efficiency
Volts	115
Hz	60
Watts	104
Amps	0.95
CFM	1200
Wt. (lbs.)	23

## Sound Level Calculations

Based on non-reflective area

Hanging Height	dBA*
40 feet	35.5
50 feet	33.3
60 feet	31.5

## Fan Speed vs CFM and Power Usage

